

THIS DRAWING IS UNPUBLISHED.

RELEASED FOR PUBLICATION

ALL RIGHTS RESERVED.

© COPYRIGHT - By -

LOC ES DIST 00

REVISIONS

P	LTR	DESCRIPTION	DATE	DWN	APVD
D1		ECR-20-010787	27AUG20	T.Q	W.H

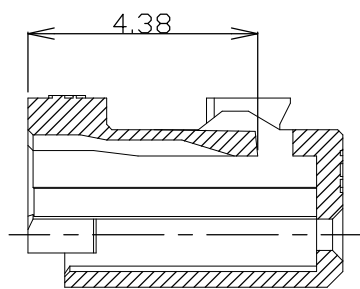
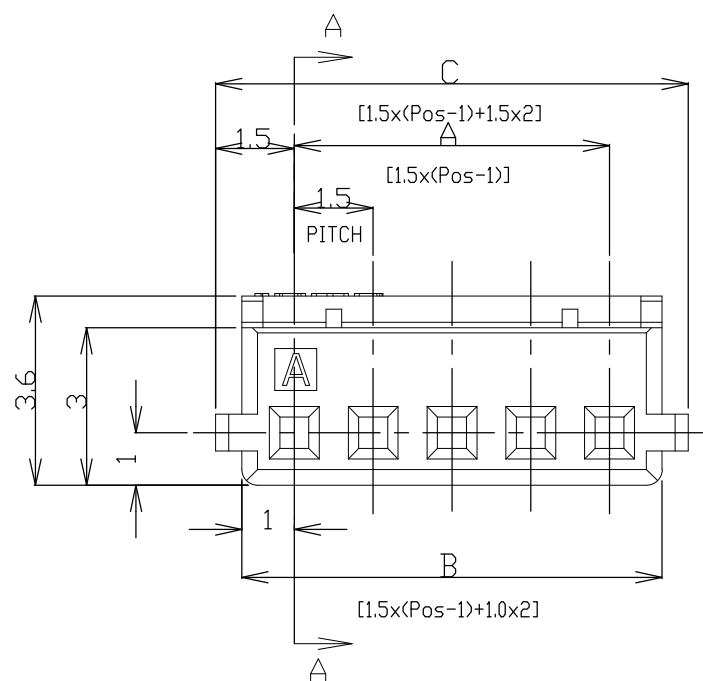
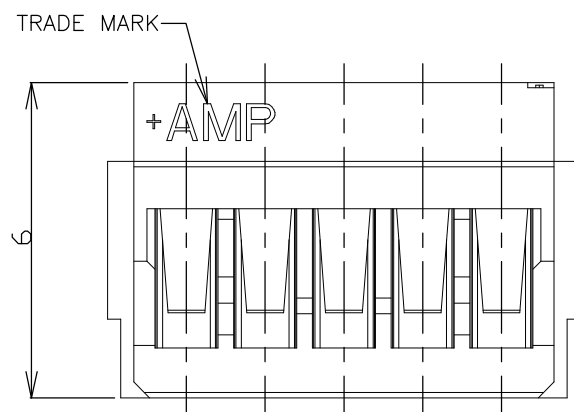
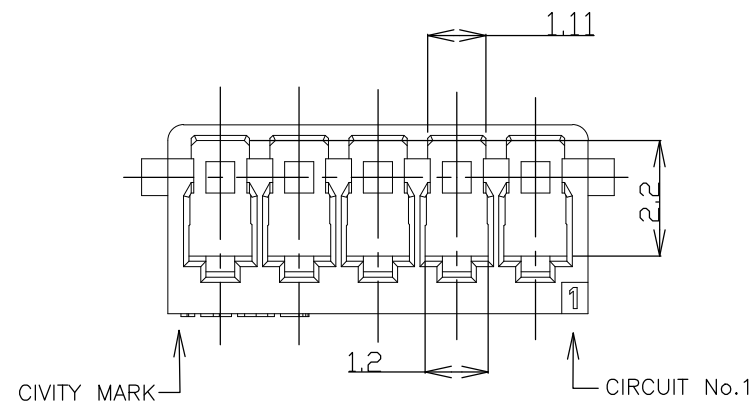
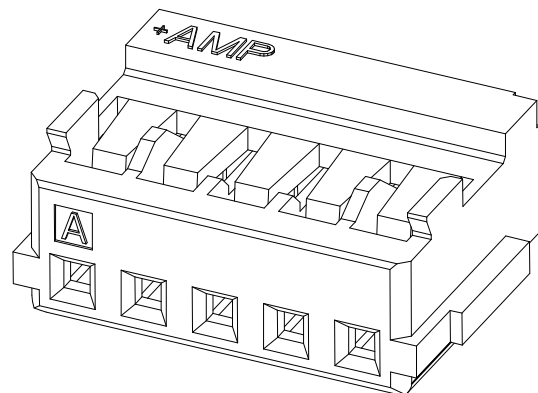

SECTION A-A

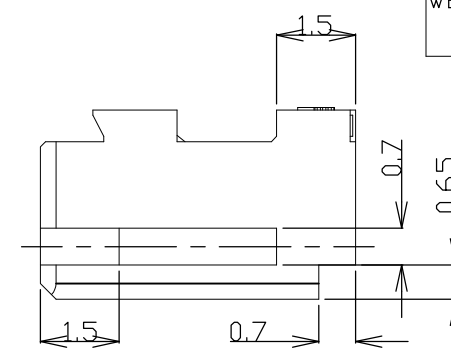

WEIGHT (g)	C	B	A	Pos	BLUE	WHITE
0.30	31.5	30.5	28.5	20	8-353908-0	2-353908-0
0.29	30.0	29.0	27.0	19	7-353908-9	1-353908-9
0.27	28.5	27.5	25.5	18	7-353908-8	1-353908-8
0.26	27.0	26.0	24.0	17	7-353908-7	1-353908-7
0.24	25.5	24.5	22.5	16	7-353908-6	1-353908-6
0.23	24.0	23.0	21.0	15	7-353908-5	1-353908-5
0.21	22.5	21.5	19.5	14	7-353908-4	1-353908-4
0.20	21.0	20.0	18.0	13	7-353908-3	1-353908-3
0.19	19.5	18.5	16.5	12	7-353908-2	1-353908-2
0.17	18.0	17.0	15.0	11	7-353908-1	1-353908-1
0.16	16.5	15.5	13.5	10	7-353908-0	1-353908-0
0.14	15.0	14.0	12.0	9	6-353908-9	353908-9
0.13	13.5	12.5	10.5	8	6-353908-8	353908-8
0.13	12.0	11.0	9.0	7	6-353908-7	353908-7
0.10	10.5	9.5	7.5	6	6-353908-6	353908-6
0.09	9.0	8.0	6.0	5	6-353908-5	353908-5
0.07	7.5	6.5	4.5	4	6-353908-4	353908-4
0.06	6.0	5.0	3.0	3	6-353908-3	353908-3
0.04	4.5	3.5	1.5	2	6-353908-2	353908-2
	C	B	A	Pos	BLUE	WHITE
	DIMENSIONS				P/N	

- NOTES:
- APPLICABLE WIRE SIZE: AWG#24~#30(0.22mm<sup>2</sup>~0.05mm<sup>2</sup>).  
INSULATION DIAMETER: 0.7mm~1.03mm.
  - USE WITH RECEPTACLE CONTACT P/N  
AWG#24~#28: 353907-1, 353918-1(L/P)

THIS DRAWING IS A CONTROLLED DOCUMENT.

DIMENSIONS:

mm

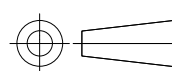

GENERAL TOLERANCE

10 ≥ : ±0.2  
 30 ≥ > 10: ±0.25  
 100 ≥ > 30: ±0.3  
 ANGLES: ±3°

MATERIAL

66NYLON  
UL94 V-0

TOLERANCES UNLESS OTHERWISE SPECIFIED:

0 PLC ± -  
 1 PLC ± -  
 2 PLC ± -  
 3 PLC ± -  
 4 PLC ± -  
 ANGLES ± -

FINISH

WIRE RANGE



INSULATION DIA



DWN H.HOSHINO 26.APR.'97

CHK J.TANIGAWA 26.APR.'97

APVD S.KUBONOHI 10.MAR.'99

PRODUCT SPEC

108-60025

APPLICATION SPEC

114-5245

WEIGHT

CUSTOMER DRAWING

STE TE Connectivity

NAME AMP MINI COMMON TERMINATED (CT)  
 CONNECTOR 1.5mm PITCH  
 HOUSING, CRIMP TYPE

SIZE A3 CAGE CODE 00779 DRAWING NO C-353908 RESTRICTED TO

SCALE NON SHEET 1 of 2 REV D1

THIS DRAWING IS UNPUBLISHED. RELEASED FOR PUBLICATION  
 © COPYRIGHT - By - ALL RIGHTS RESERVED.

LOC	DIST	REVISIONS					
ES	00	P	LTR	DESCRIPTION	DATE	DWN	APVD
		-		SEE SHEET 1	-	-	-

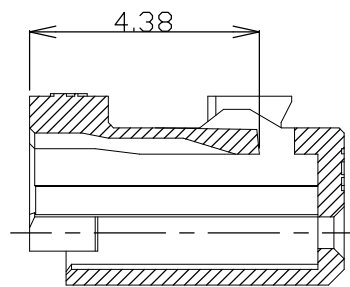
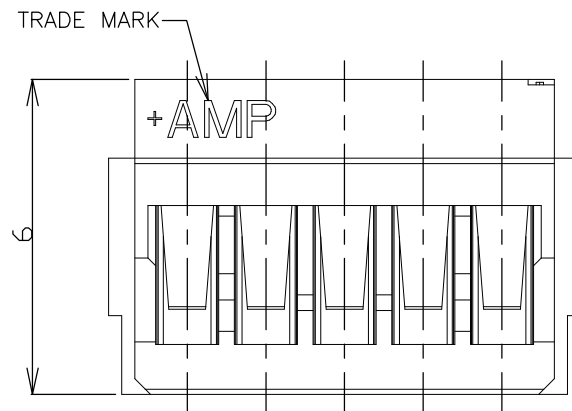
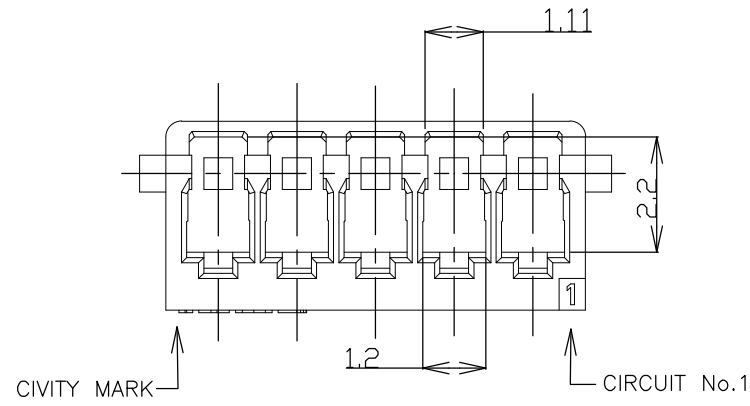
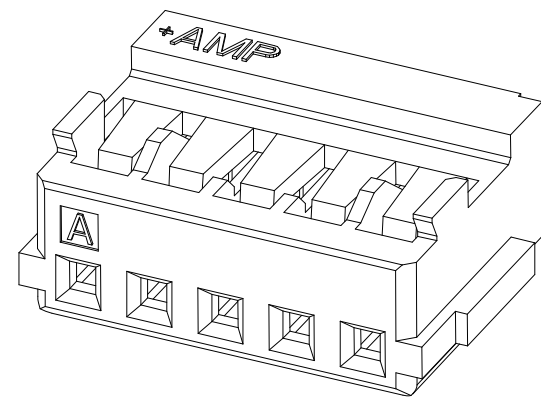

SECTION A-A

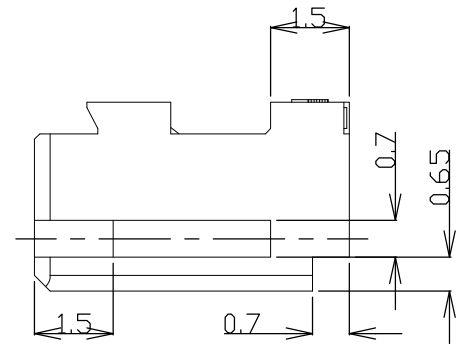
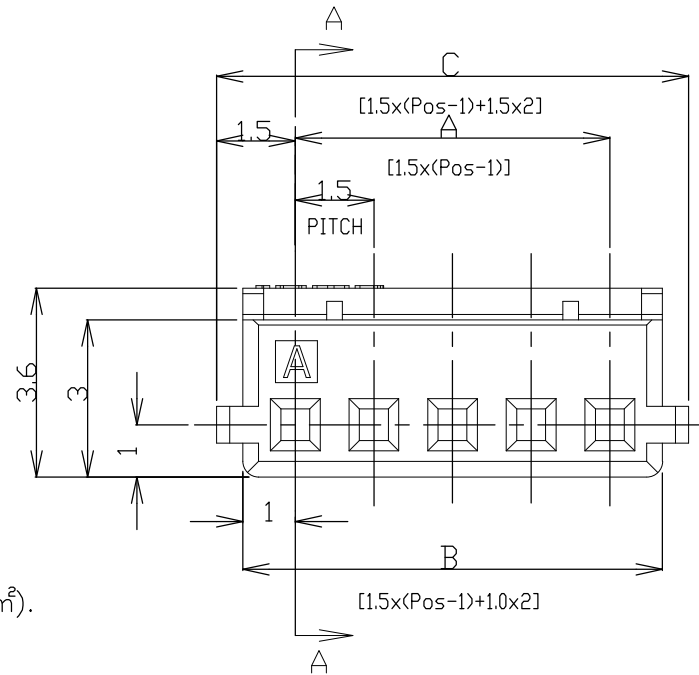

OBSOLETE ALL GLOW WIRE PARTS ON THIS SHEET.

0.30	31.5	30.5	28.5	20	4-353908-0
0.29	30.0	29.0	27.0	19	3-353908-9
0.27	28.5	27.5	25.5	18	3-353908-8
0.26	27.0	26.0	24.0	17	3-353908-7
0.24	25.5	24.5	22.5	16	3-353908-6
0.23	24.0	23.0	21.0	15	3-353908-5
0.21	22.5	21.5	19.5	14	3-353908-4
0.20	21.0	20.0	18.0	13	3-353908-3
0.19	19.5	18.5	16.5	12	3-353908-2
0.17	18.0	17.0	15.0	11	3-353908-1
0.16	16.5	15.5	13.5	10	3-353908-0
0.14	15.0	14.0	12.0	9	2-353908-9
0.13	13.5	12.5	10.5	8	2-353908-8
0.13	12.0	11.0	9.0	7	2-353908-7
0.10	10.5	9.5	7.5	6	2-353908-6
0.09	9.0	8.0	6.0	5	2-353908-5
0.07	7.5	6.5	4.5	4	2-353908-4
0.06	6.0	5.0	3.0	3	2-353908-3
0.04	4.5	3.5	1.5	2	2-353908-2
WEIGHT (g)	C	B	A	Pos	WHITE P/N
	DIMENSIONS				

- NOTES:
- APPLICABLE WIRE SIZE: AWG#24~#30(0.22mm<sup>2</sup>~0.05mm<sup>2</sup>). INSULATION DIAMETER: 0.7mm~1.03mm.
  - USE WITH RECEPTACLE CONTACT P/N AWG#24~#28: 353907-1, 353918-1(L/P)
  - COMPLY WITH GLOW WIRE REQUIREMENTS FOR PARTS OF NON-METALLIC MATERIAL SUPPORTING A CURRENT-CARRYING CONNECTION DETAILED IN IEC 60335-1, SECTION 30(GWT).

THIS DRAWING IS A CONTROLLED DOCUMENT.		DWN H.HOSHINO 26.APR.'97	 TE Connectivity		
DIMENSIONS: mm		CHK J.TANIGAWA 26.APR.'97			
TOLERANCES UNLESS OTHERWISE SPECIFIED:		APVD S.KUBONOHI 10.MAR.'99	NAME		
0 PLC ± - 1 PLC ± - 2 PLC ± - 3 PLC ± - 4 PLC ± - ANGLES ± - FINISH -		PRODUCT SPEC 108-60025	AMP MINI COMMON TERMINATED (CT) CONNECTOR 1.5mm PITCH HOUSING, CRIMP TYPE		
MATERIAL 6 NYLON UL94 V-2		APPLICATION SPEC 114-5245	SIZE A3	CAGE CODE 00779	DRAWING NO C-353908
		WEIGHT	RESTRICTED TO		
		CUSTOMER DRAWING	SCALE NON	SHEET 2 OF 2	REV D1