



Typical Applications

Central door lock, Power doors & windows, Turning lamp control, Mirror adjustment, Seat adjustment, Speed-limit indicator control, Warm-up control, Wiper control

Features

- Tight structure and light weight
- High current contact capacity (Carrying current: 35A/10min 25A/1h)
- Improved heat resistance
- Reflow soldering version available
- RoHS & ELV compliant

CHARACTERISTICS

Contact arrangement	1A, 1C
Voltage drop (initial) ¹⁾	Typ.: 50mV (at 10A) Max.: 250mV (at 10A)
Max. continuous current ²⁾	35A (at 23°C, 10min) 25A (at 23°C, 1h)
Max. switching current ³⁾	NO: 35A NC: 20A
Max. switching voltage	16VDC
Min. contact load	1A 6VDC
Electrical endurance	See "CONTACT DATA"
Mechanical endurance	1 x 10 ⁷ OPS (300OPS/min)
Initial insulation resistance	100MΩ (at 500VDC)
Dielectric strength ⁴⁾	500VAC
Operate time	Max.: 10ms (at nomi. vol.)
Release time ⁵⁾	Max.: 5ms
Ambient temperature	Plastic sealed:-40°C to 85°C Fluxproofed:-40°C to 125°C

Vibration resistance ⁶⁾	10Hz to 55Hz 1.5mm DA
Shock resistance ⁶⁾	98m/s ²
Termination	PCB ⁷⁾
Construction	Plastic sealed, Flux proofed
Unit weight	Approx. 6g

- 1) Equivalent to the max. initial contact resistance is 100mΩ (at 1A 6VDC).
- 2) Test under the following conditions:
 - a. The relay is mounted on the PCB, the coil is applied with 100% rated voltage;
 - b. The PCB board is a double layer board. The thickness of the copper foil is 4 oz (140μm), the width of each copper foil is 4.86x(1±5%)mm, the length of the copper foil is (50±1)mm, and the Tg value of the PCB board is 150°C;
 - c. The sample orders were only tested.
- 3) At 23°C, 13.5VDC (100 cycles, resistive load).
- 4) 1min, leakage current less than 1mA.
- 5) The value is measured when voltage drops suddenly from nominal voltage to 0VDC and coil is not paralleled with suppression circuit.
- 6) When energized, opening time of NO contacts shall not exceed 100μs, when non-energized, opening time of NC contacts shall not exceed 100μs, meantime, NO contacts shall not be closed.
- 7) Since it is an environmental friendly product, please select lead-free solder when welding. The recommended soldering temperature and time is (260±3)°C, (5±0.3)s.

CONTACT DATA⁵⁾

at 23°C

Load voltage	Load type		Load current A			On/Off ratio		Electrical endurance OPS	Contact material	Load wiring diagram ⁴⁾
			1C		1A	On s	Off s			
			NO	NC						
13.5VDC	Resistive	Make	20	10	20	2	2	2×10 ⁵	AgSnO ₂	See diagram 1
		Break	20	10	20	2	2			
	Resistive	Make	30	---	30	2	2	1×10 ⁵	AgSnO ₂	See diagram 2
		Break	30	---	30					
	Motor Locked	Make	25 ³⁾	---	25 ³⁾	0.2	2	1×10 ⁵	AgSnO ₂	See diagram 3
		Break	25 ³⁾	---	25 ³⁾					



HONGFA RELAY

ISO9001, IATF16949, ISO14001, OHSAS18001, IECQ QC 080000 CERTIFIED

2023 Rev. 1.00

Load voltage	Load type		Load current A			On/Off ratio		Electrical endurance OPS	Contact material	Load wiring diagram ⁴⁾
			1C		1A	On s	Off s			
			NO	NC	NO					
13.5VDC	Lamp ¹⁾	Make	90 ²⁾	---	90 ²⁾	1	9	1×10 ⁵ (at 85°C)	AgSnO ₂	See diagram 4
		Break	8.8	---	8.8					
	Lamp ¹⁾	Make	6×21W	---	6×21W	1	6	1×10 ⁵	AgSnO ₂	See diagram 4
		Break								
	Flasher	Make	3×21W	---	3×21W	0.365	0.365	2×10 ⁶	Special AgSnO ₂	See diagram 5
		Break								

1) When it is utilized in flasher, a special AgSnO₂ contact material should be used and the customer special code should be (170) as a suffix. Please connect by the polarity according to the diagram below.

2) Corresponds to the peak inrush current on initial actuation (cold filament).

3) Corresponds to the peak inrush current on initial actuation (motor).

4) The load wiring diagrams are listed below (Ratings of NO, NC are tested based on different samples separately) :

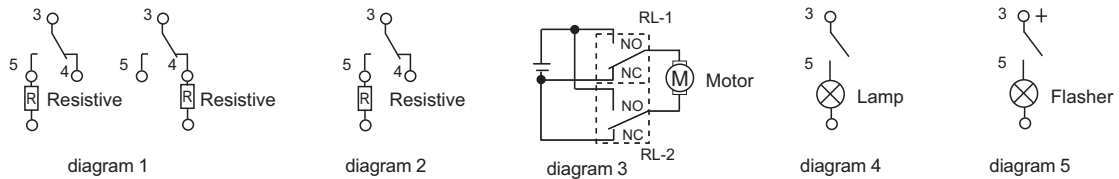

5) When the load voltage is at 24VDC or higher, or the applications conditions are different from the table above, please submit the detailed application conditions to Hongfa to get more support.

COIL DATA

Nominal voltage ¹⁾ VDC	Pick-up voltage VDC max.			Drop-out voltage VDC min.			Coil resistance x(1±10%)Ω	Power consumption W
	23°C	85°C	125°C	23°C	85°C	125°C		
6	3.6	4.5	5.1	0.5	0.6	0.7	60	0.6
9	5.4	6.8	7.6	0.7	0.8	0.9	135	0.6
10	6.3	7.9	8.9	0.8	1.0	1.1	180	0.6
12	7.3	9.2	10.3	1.0	1.2	1.4	240	0.6

1) Other types on request.

ORDERING INFORMATION

Type	HFKW /	012	-1Z	W	-L	C	(XXX)
Coil voltage	006: 6VDC	009: 9VDC	010: 10VDC	012: 12VDC			
Contact arrangement	1H: 1 Form A	1Z: 1 Form C					
Contact material	W: AgSnO ₂						
Construction ¹⁾	L: Flux proofed (Reflow soldering version)	Nil: Plastic sealed ²⁾					
Packing style	C: Tape and reel packing	Nil: Tube packing					
Special code ³⁾	XXX: Customer special requirement	Nil: Standard					

Notes: 1) The structure of HFKW/□□□-12W-L□ is only flux proof, the open vent hole is at the bottom of the base.

2) Contact is recommended for suitable condition and specifications if water cleaning or surface process is involved in assembling relays on PCB.

3) The performance parameters of products with characteristic numbers shall be subject to the specific specifications provided by Hongfa.

Outline Dimensions

1 Form A

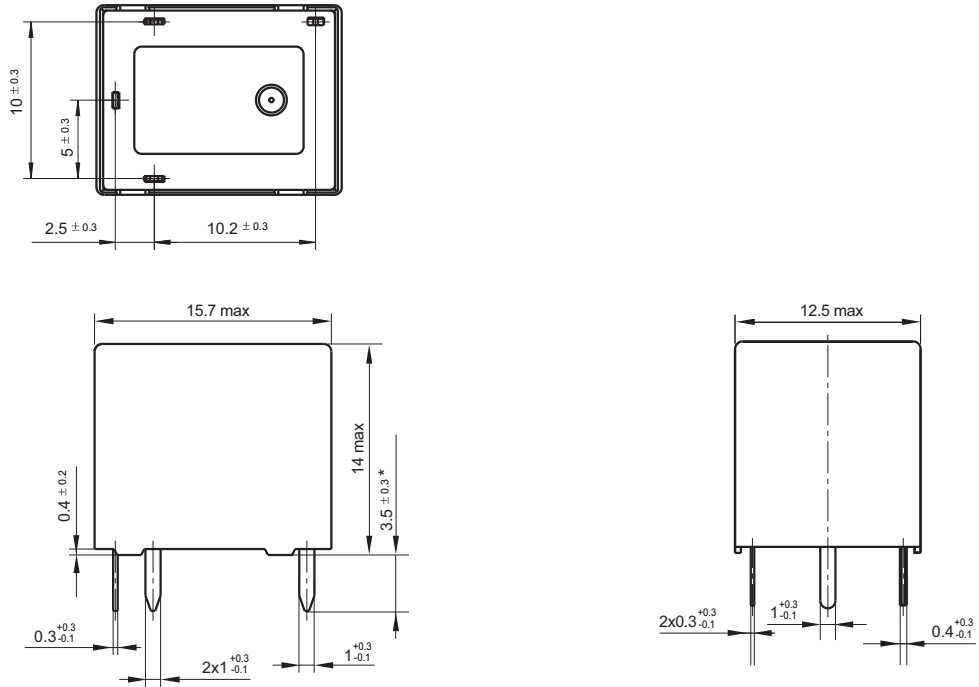

1 Form C

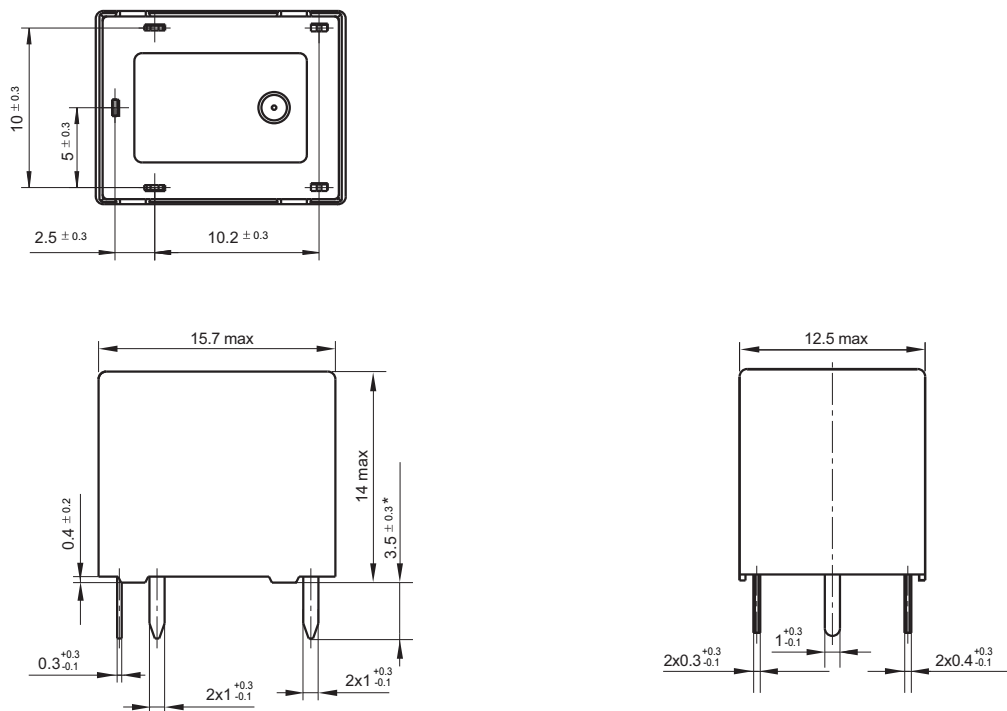

OUTLINE DIMENSIONS, WIRING DIAGRAM AND PC BOARD LAYOUT

Unit: mm

Wiring Diagram (Bottom view)

PCB Layout (Bottom view)

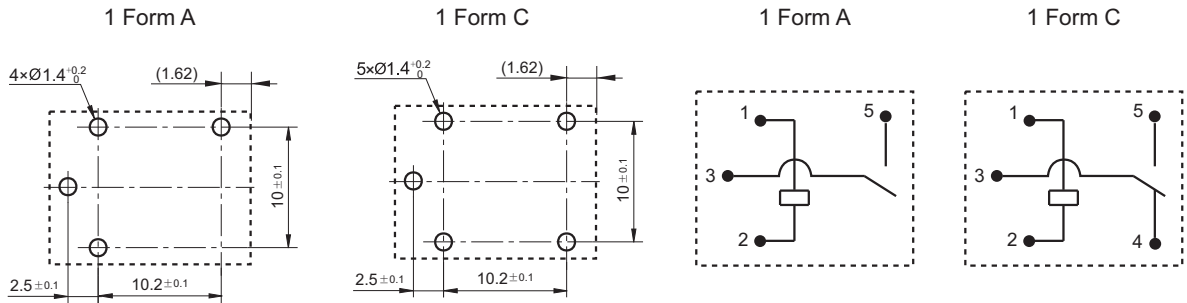

Remark: * The additional tin top is max. 1mm.

TAPE AND REEL PACKING

Unit: mm

Direction of Relay Insertion

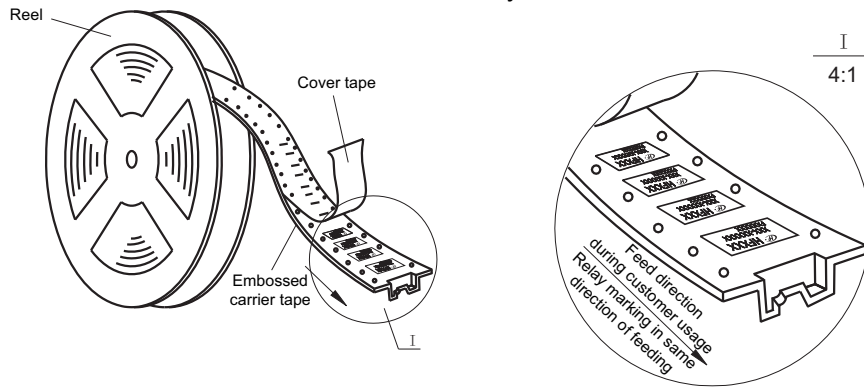

Direction of Relay Insertion

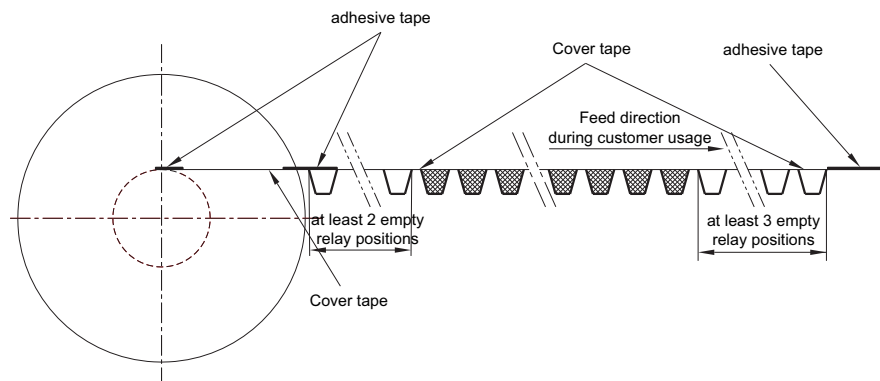

Reel Dimensions

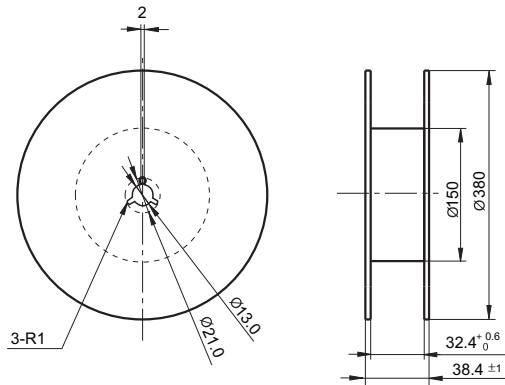

Tape Dimensions

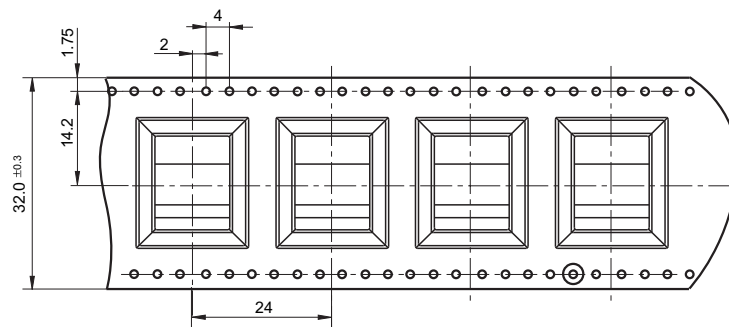

CHARACTERISTIC CURVES

1. Coil operating voltage range (NO contacts, at 13.5VDC)

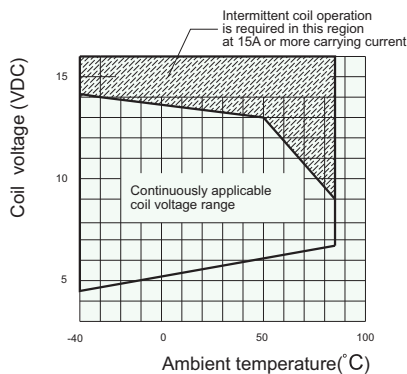

HFKW/009-1ZW(XXX)

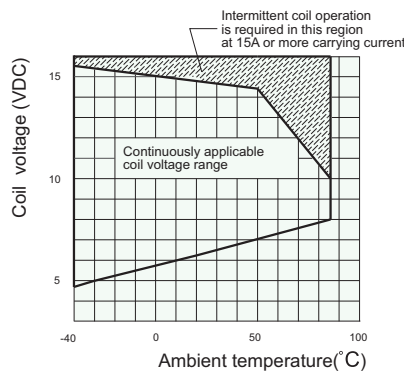

HFKW/010-1ZW(XXX)

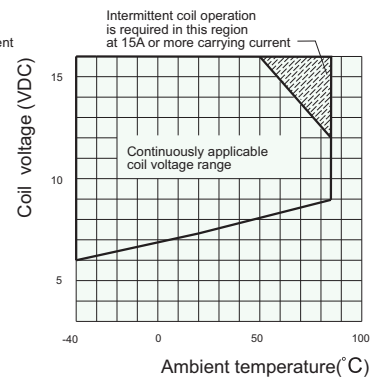

HFKW/012-1ZW(XXX)

CHARACTERISTIC CURVES

2. Load curve (NO contacts, at 23°C)

Electrical endurance curve (Motor locked)

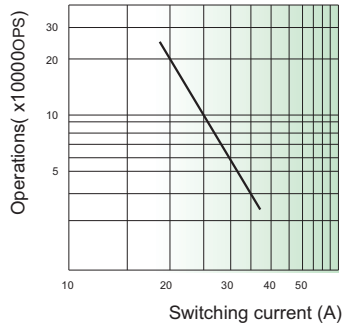

HFKW/012-1ZW(XXX)

Test conditions: 0.2s ON, 2s OFF

Coil temperature rise

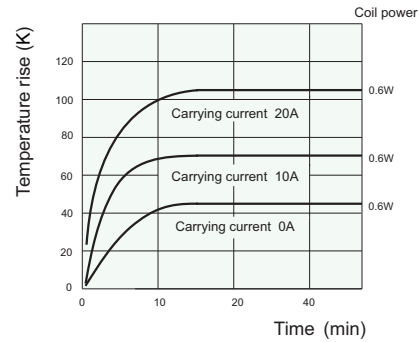

HFKW/012-1ZW(XXX)

Notes: The coil temperature rise test requires the relay to be installed on the PCB board;
 The PCB board is a double layer board;
 The thickness of the copper foil is 4 oz (140μm), the width of each copper foil is 4.86x(1±5%)mm;
 The length of the copper foil is (50±1)mm, Installation spacing is 100mm.

3. Reflow soldering, temperature on PCB board. (Recommended soldering temperature, only for reflow soldering version)

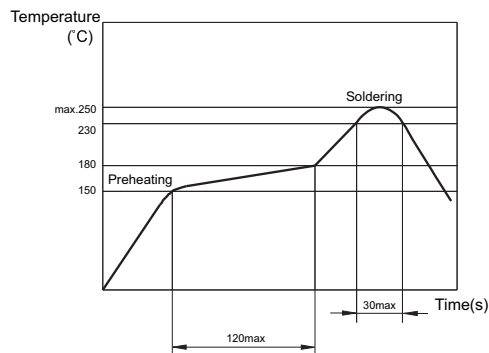

Disclaimer

The specification is for reference only. See to "Terminology and Guidelines" for more information. Specifications subject to change without notice. In case there is specific criterion (such as mission profile, technical specification, PPAP etc.) checked and agreed by and between customer and Hongfa, this specific criterion should be taken as standard regarding any requirement on Hongfa product.

We could not evaluate all the performance and all the parameters for every possible application. Thus the user should be in a right position to choose the suitable product for their own application. If there is any query, please contact Hongfa for the technical service. However, it is the user's responsibility to determine which product should be used only.

© Xiamen Hongfa Electroacoustic Co., Ltd. All rights of Hongfa are reserved.