

# PLCC-4 Package Full-Color SMD LED

## VR 5RE08

### Description

The constructive of this series of LED are different from the PCB type SMD LED. The lead-frame is of metal, reflector is made of thermoplastic and construct into this unique type of SMD LED. The wavelengths and luminous Intensities of this series are grouped under 20mA for uniformity.

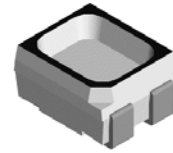

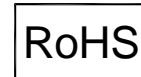

### Applications

- Dashboards and switch
- Backlight keypads
- Industrial control systems signal indicator
- Automotive features
- Telephone and fax backlighting or indicator



### Electronic Optical Characteristics (at 20mA):

Part Number	Emitted Color	$\lambda$ (nm)		Lens Color	Iv(mcd)		View Angle (2 $\theta$ 1/2)	VF(V)	
		$\lambda_d$	$\lambda_p$		Min.	Typ.		Typ.	Max.
VR 5RE08	Red 	624	631	Clear	450	600	120	2.0	2.4
	Green 	525	518		900	1200		3.3	3.8
	Blue 	470	468		225	350		3.3	3.8

### Absolute Maximum Ratings (at Ta=25°C)

Emitted Color	P <sub>D</sub> (mW)	I <sub>F</sub> (mA)	I <sub>FP</sub> (mA)	I <sub>R</sub> ( $\mu$ A) @VR=5V	T <sub>opr</sub> (°C)	T <sub>stg</sub> (°C)
Red	120	50	100	10	-40~+85	-40~+100
Green	110	30	100	50	-40~+85	-40~+100
Blue	100	30	100	50	-40~+85	-40~+100

Note: Please take note the Absolute Maximum Rating values. Any operation beyond the specified ratings in this table will result degradation of LED life- span and may cause LED to fail.

\* I<sub>FP</sub> = Peak Forward Current under 1/10 duty, 1KHz condition

**Package Dimension:**

unit:mm

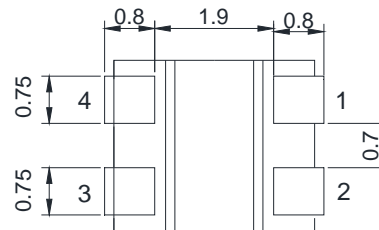
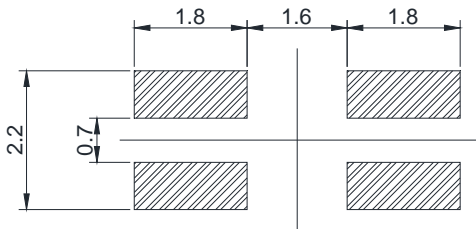
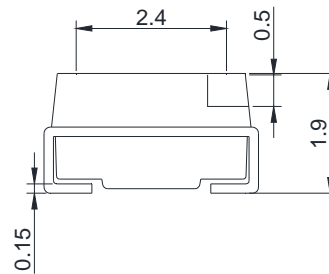
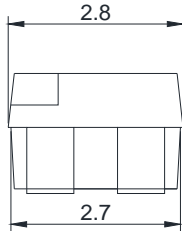
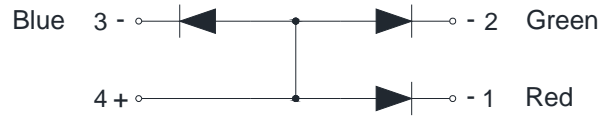
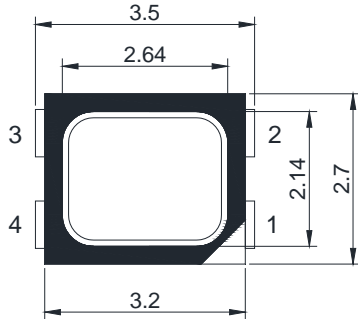

Recommended Soldering Pad

**Notes:**

1. All dimensions are millimeters.
2. Tolerance is  $\pm 0.2\text{mm}$  unless otherwise specified.
3. Specifications are subject to change without notice.

## Optical Characteristics Curves

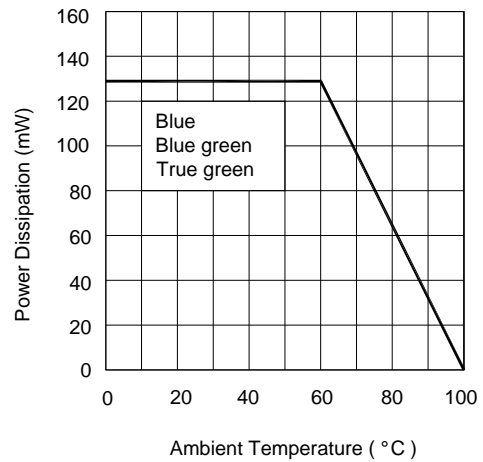
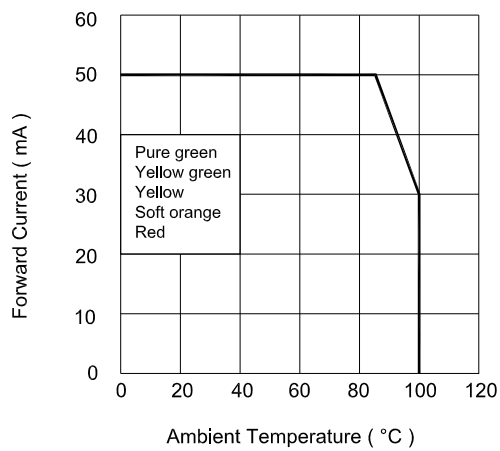
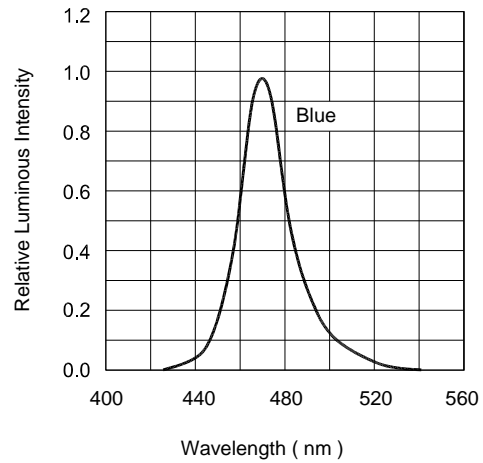
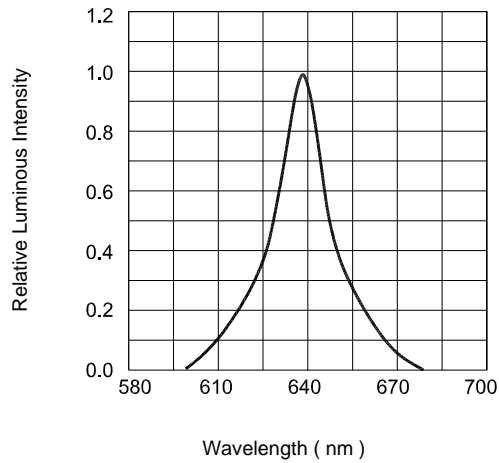
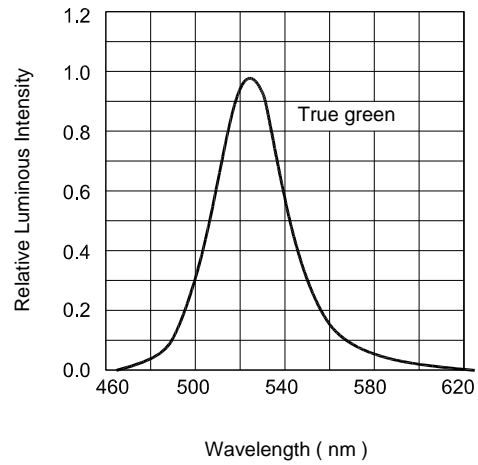
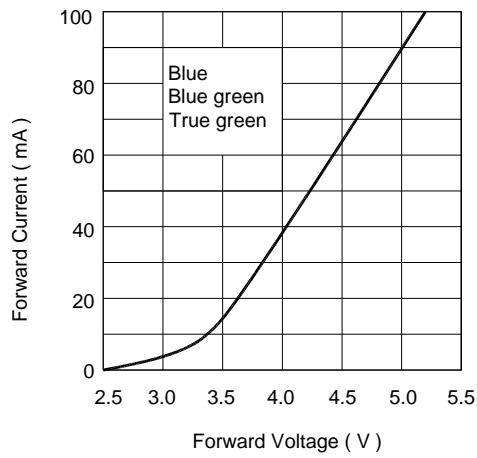

**Reel Dimension:**

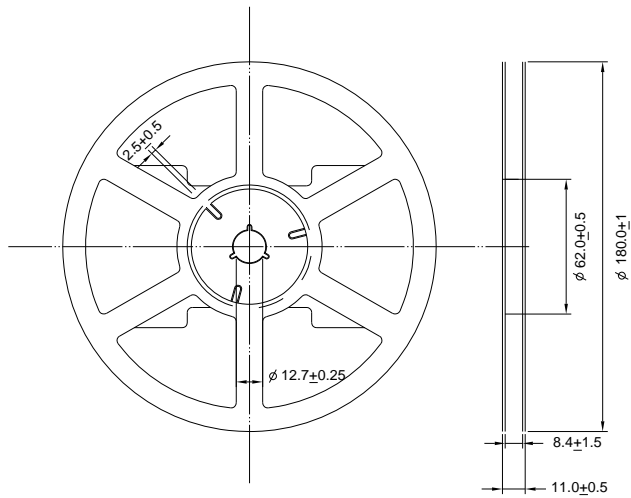

**Note:**

Available in 8mm carrier tape on 178mm diameter reels. (1000 pieces)

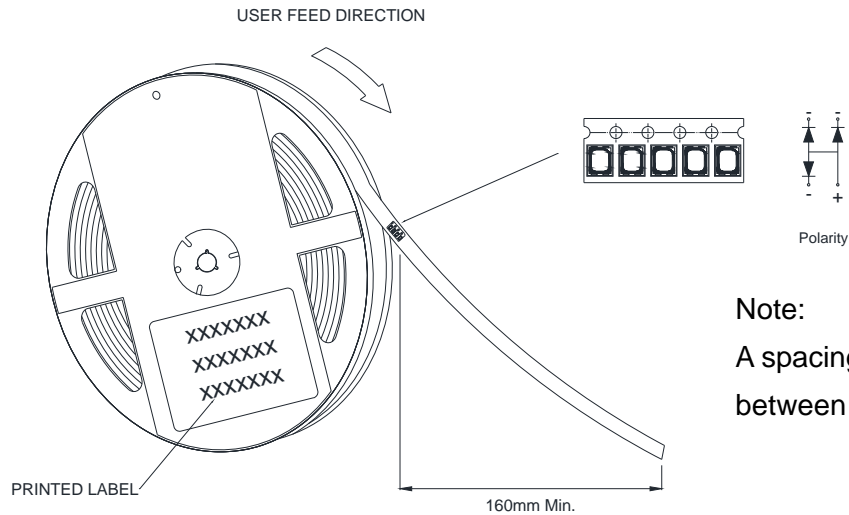

**Note:**

A spacing of approximately 160mm between the front edge of tape

**Tape Dimension:**

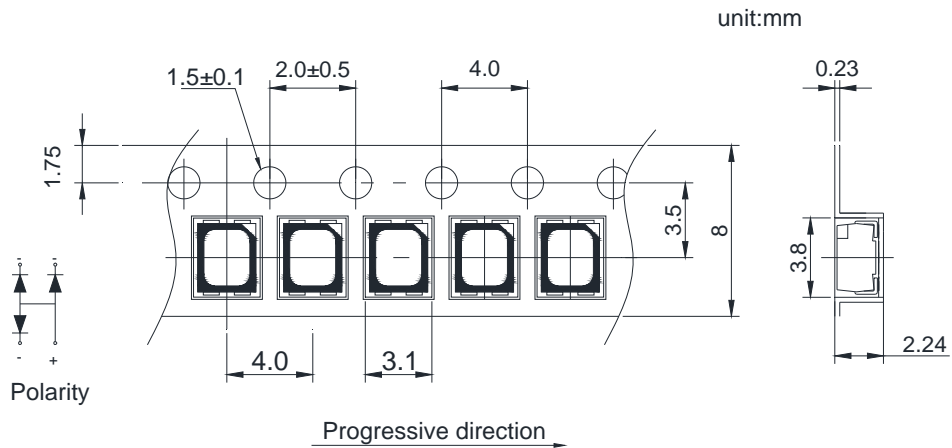

**Recommended re-flow soldering profile:**

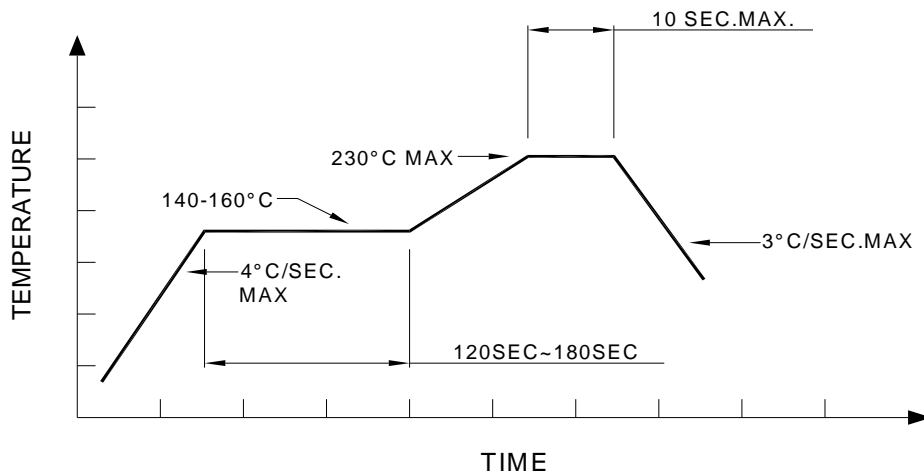

**Recommended Pb-free re-flow soldering profile:**

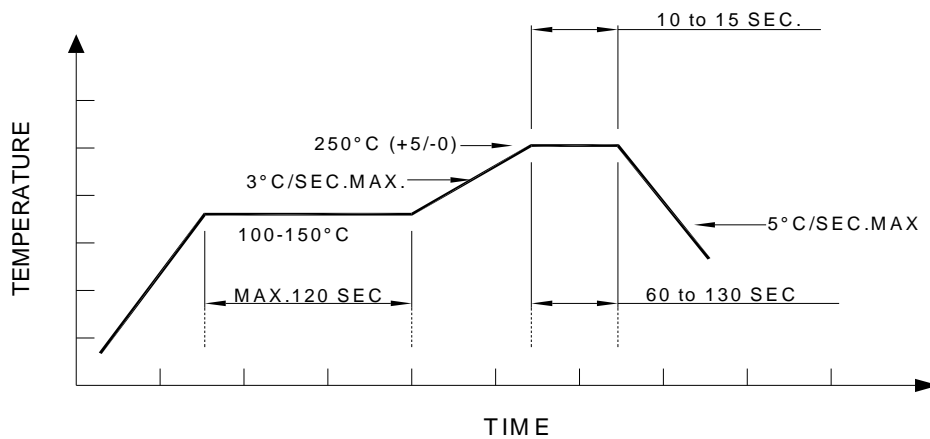

**Note:**

All the specifications listed in this data sheet are suitable for general electronic equipment, office equipment and communication devices. Kindly consult Sales Representatives for specific reliabilities request, Forward Voltage, Luminous Intensity, Wavelength, Radiant Power or Viewing Angle.