

SMAG Plastic-Encapsulate Diodes

SMAJ SERIES Transient Voltage Suppressor Diodes

KEY PARAMETERS		
PARAMETER	VALUE	UNIT
V_{RWM}	5-220	V
I_R	800-1	uA
I_{PP}	43.48-1.12	A
V_C	9.2-356	V
P_{PPM}	400	W

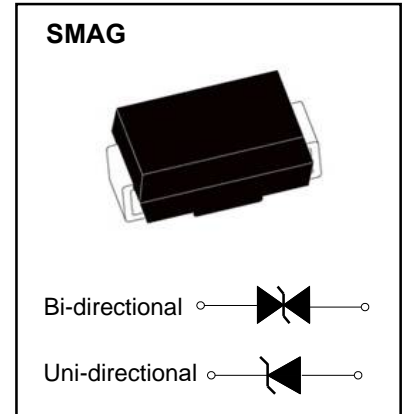

Features

- For surface mounted applications in order to optimize board space
- Glass passivated chip junction
- Excellent clamping capability
- Low reverse leakage
- Very fast response time
- 400 W peak pulse power capability with a 10/1000 us waveform by 0.01% duty cycle
- RoHS Compliant
- ESD protection of data lines in accordance with IEC 61000-4-2, 30 kV(Air),30 kV (Contact)

Mechanical Data

- Case: SMA(DO-214)
- Molding compound meets UL 94V-0 flammability rating
- Moisture sensitivity level: level 1, per J-STD-020
- Polarity: Color band denotes cathode end

Marking

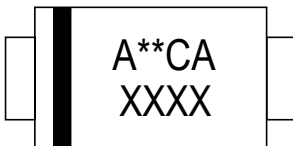

Cathode Band:for uni-directional products only

A**CA = Device code, **=Voltage

C:Bi-directional or not

XXXX=Data Code

Electrical Characteristics ($T_A=25^{\circ}\text{C}$ unless otherwise noted)

Limiting Values (Absolute Maximum Rating)

Item	Symbol	Unit	Conditions	Max
Peak pulse power dissipation	P_{PPM}	W	with a 10/1000us waveform	400
Peak pulse current(note 1)	I_{PPM}	A	with a 10/1000us waveform	See Next Table
Power dissipation	P_D	W	On infinite heat sink at $T_L=50^{\circ}\text{C}$	3.3
Peak forward surge current	I_{FSM}	A	8.3 ms single half sine-wave uni-directional only $\leq 10^{\circ}\text{C}$	60
Operating junction and storage temperature range	T_J, T_{STG}	$^{\circ}\text{C}$		-55 to +150

Electrical Characteristics ($T_a=25^{\circ}\text{C}$ Unless otherwise specified)

Item	Symbol	Unit	Conditions	Max
Maximum instantaneous forward Voltage	V_F	V	at 25A for uni-directional only	3.5
Thermal resistance	$R_{\theta JL}$	$^{\circ}\text{C}/\text{W}$	junction to lead $T_L=50^{\circ}\text{C}$	30
	$R_{\theta JA}$	$^{\circ}\text{C}/\text{W}$	junction to ambient $T_A=25^{\circ}\text{C}$	120

Notes:

- (1) Non-repetitive current pulse, per Fig. 3 and derated above $T_A=25^{\circ}\text{C}$ per Fig.2
- (2) 8.3ms single half sine-wave or equivalent square wave, duty cycle=4 pulses per minutes maximum
- (3) Thermal resistance from junction to ambient and from junction to lead mounted on 1" x 1"(25.4mm x 25.4mm) FR4 PCB, double sided copper, with minimum pad layout

Electrical Characteristics (T_A=25°C unless otherwise noted)

Part Number		Device Marking Code		Breakdown Voltage VBR@IT		Test Current	Max Reverse Leakage @V _{RWM}	Reverse Standoff Voltage	Max Peak Pulse Current ⁽¹⁾	Max Clamping Voltage @I _{PP}
UNI	BI	UNI	BI	Min.(V)	Max.(V)	IT(mA)	I _R (uA)	V _{RWM} (V)	I _{PP} (A)	V _c (V)
SMAJ5.0A	SMAJ5.0CA	A5.0A XXXX ⁽²⁾	A5.0CA XXXX	6.4	7.0	10	800	5.0	43.48	9.2
SMAJ6.0A	SMAJ6.0CA	A6.0A XXXX	A6.0CA XXXX	6.7	7.4	10	800	6.0	38.83	10.3
SMAJ6.5A	SMAJ6.5CA	A6.5A XXXX	A6.5CA XXXX	7.2	8.0	10	500	6.5	35.71	11.2
SMAJ7.0A	SMAJ7.0CA	A7.0A XXXX	A7.0CA XXXX	7.8	8.6	10	200	7.0	33.33	12.0
SMAJ7.5A	SMAJ7.5CA	A7.5A XXXX	A7.5CA XXXX	8.3	9.2	1	100	7.5	31.01	12.9
SMAJ8.0A	SMAJ8.0CA	A8.0A XXXX	A8.0CA XXXX	8.9	9.8	1	50	8.0	29.41	13.6
SMAJ8.5A	SMAJ8.5CA	A8.5A XXXX	A8.5CA XXXX	9.4	10.4	1	10	8.5	27.78	14.4
SMAJ9.0A	SMAJ9.0CA	A9.0A XXXX	A9.0CA XXXX	10.0	11.1	1	5	9.0	25.97	15.4
SMAJ10A	SMAJ10CA	A10A XXXX	A10CA XXXX	11.1	12.3	1	5	10	23.53	17.0
SMAJ11A	SMAJ11CA	A11A XXXX	A11CA XXXX	12.2	13.5	1	1	11	21.98	18.2
SMAJ12A	SMAJ12CA	A12A XXXX	A12CA XXXX	13.3	14.7	1	1	12	20.10	19.9
SMAJ13A	SMAJ13CA	A13A XXXX	A13CA XXXX	14.4	15.9	1	1	13	18.60	21.5
SMAJ14A	SMAJ14CA	A14A XXXX	A14CA XXXX	15.6	17.2	1	1	14	17.24	23.2
SMAJ15A	SMAJ15CA	A15A XXXX	A15CA XXXX	16.7	18.5	1	1	15	16.39	24.4
SMAJ16A	SMAJ16CA	A16A XXXX	A16CA XXXX	17.8	19.7	1	1	16	15.38	26.0
SMAJ17A	SMAJ17CA	A17A XXXX	A17CA XXXX	18.9	20.9	1	1	17	14.49	27.6
SMAJ18A	SMAJ18CA	A18A XXXX	A18CA XXXX	20.0	22.1	1	1	18	13.70	29.2
SMAJ20A	SMAJ20CA	A20A XXXX	A20CA XXXX	22.2	24.5	1	1	20	12.35	32.4
SMAJ22A	SMAJ22CA	A22A XXXX	A22CA XXXX	24.4	26.9	1	1	22	11.27	35.5
SMAJ24A	SMAJ24CA	A24A XXXX	A24CA XXXX	26.7	29.5	1	1	24	10.28	38.9
SMAJ26A	SMAJ26CA	A26A XXXX	A26CA XXXX	28.9	31.9	1	1	26	9.50	42.1
SMAJ28A	SMAJ28CA	A28A XXXX	A28CA XXXX	31.1	34.4	1	1	28	8.81	45.4
SMAJ30A	SMAJ30CA	A30A XXXX	A30CA XXXX	33.3	36.8	1	1	30	8.26	48.4
SMAJ33A	SMAJ33CA	A33A XXXX	A33CA XXXX	36.7	40.6	1	1	33	7.50	53.3
SMAJ36A	SMAJ36CA	A36A XXXX	A36CA XXXX	40.0	44.2	1	1	36	6.88	58.1
SMAJ40A	SMAJ40CA	A40A XXXX	A40CA XXXX	44.4	49.1	1	1	40	6.20	64.5
SMAJ43A	SMAJ43CA	A43A XXXX	A43CA XXXX	47.8	52.8	1	1	43	5.76	69.4
SMAJ45A	SMAJ45CA	A45A XXXX	A45CA XXXX	50.0	55.3	1	1	45	5.50	72.7
SMAJ48A	SMAJ48CA	A48A XXXX	A48CA XXXX	53.3	58.9	1	1	48	5.17	77.4
SMAJ51A	SMAJ51CA	A51A XXXX	A51CA XXXX	56.7	62.7	1	1	51	4.85	82.4

Electrical Characteristics ($T_A=25^\circ\text{C}$ unless otherwise noted)

Part Number		Device Marking Code		Breakdown Voltage VBR@IT		Test Current	Max Reverse Leakage @ V_{RWM}	Reverse Standoff Voltage	Max Peak Pulse Current ⁽¹⁾	Max Clamping Voltage @ I_{PP}
UNI	BI	UNI	BI	Min.(V)	Max.(V)	IT(mA)	I_R (μA)	V_{RWM} (V)	I_{PP} (A)	Vc(V)
SMAJ54A	SMAJ54CA	A54A XXXX ⁽²⁾	A54CA XXXX	60.0	66.3	1	1	54	4.59	87.1
SMAJ58A	SMAJ58CA	A58A XXXX	A58CA XXXX	64.4	71.2	1	1	58	4.27	93.6
SMAJ60A	SMAJ60CA	A60A XXXX	A60CA XXXX	66.7	73.7	1	1	60	4.13	96.8
SMAJ64A	SMAJ64CA	A64A XXXX	A64CA XXXX	71.1	78.6	1	1	64	3.88	103.0
SMAJ70A	SMAJ70CA	A70A XXXX	A70CA XXXX	77.8	86.0	1	1	70	3.54	113.0
SMAJ75A	SMAJ75CA	A75A XXXX	A75CA XXXX	83.3	92.1	1	1	75	3.31	121.0
SMAJ78A	SMAJ78CA	A78A XXXX	A78CA XXXX	86.7	95.8	1	1	78	3.17	126.0
SMAJ85A	SMAJ85CA	A85A XXXX	A85CA XXXX	94.4	104.0	1	1	85	2.92	137.0
SMAJ90A	SMAJ90CA	A90A XXXX	A90CA XXXX	100.0	111.0	1	1	90	2.74	146.0
SMAJ100A	SMAJ100CA	A100A XXXX	A100CA XXXX	111.0	123.0	1	1	100	2.47	162.0
SMAJ110A	SMAJ110CA	A110A XXXX	A110CA XXXX	122.0	135.0	1	1	110	2.26	177.0
SMAJ120A	SMAJ120CA	A120A XXXX	A120CA XXXX	133.0	147.0	1	1	120	2.07	193.0
SMAJ130A	SMAJ130CA	A130A XXXX	A130CA XXXX	144.0	159.0	1	1	130	1.91	209.0
SMAJ150A	SMAJ150CA	A150A XXXX	A150CA XXXX	167.0	185.0	1	1	150	1.65	243.0
SMAJ160A	SMAJ160CA	A160A XXXX	A160CA XXXX	178.0	197.0	1	1	160	1.54	259.0
SMAJ170A	SMAJ170CA	A170A XXXX	A170CA XXXX	189.0	209.0	1	1	170	1.45	275.0
SMAJ180A	SMAJ180CA	A180A XXXX	A180CA XXXX	200.0	220.0	1	1	180	1.37	291.0
SMAJ190A	SMAJ190CA	A190A XXXX	A190CA XXXX	211.0	232.0	1	1	190	1.30	307.0
SMAJ200A	SMAJ200CA	A200A XXXX	A200CA XXXX	224.0	247.0	1	1	200	1.23	324.0
SMAJ220A	SMAJ220CA	A220A XXXX	A220CA XXXX	246.0	272.0	1	1	220	1.12	356.0

Notes:

- (1) Waveform of SMAJ5.0A -SMAJ220CA are defined as per fig.3
- (2) XXXX=Code

Figure 1. Peak Pulse Power Rating Curve

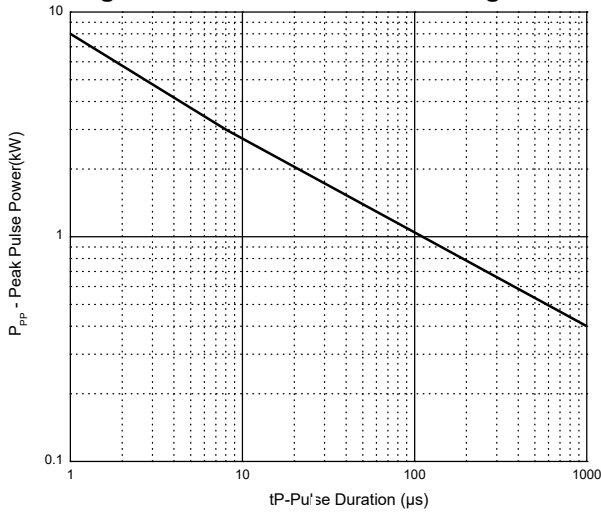

Figure 2. Pulse Derating Curve

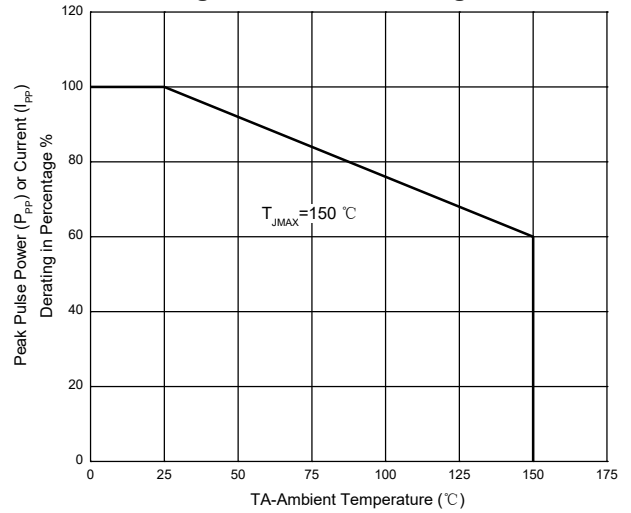

Figure 3. Pulse Waveform

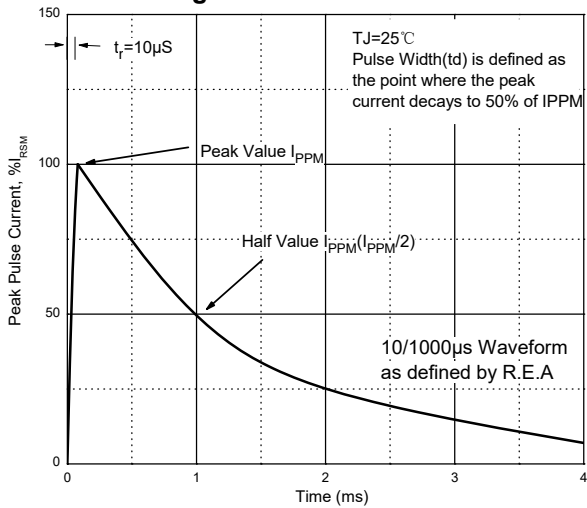

Figure 4. Typical Junction Capacitance

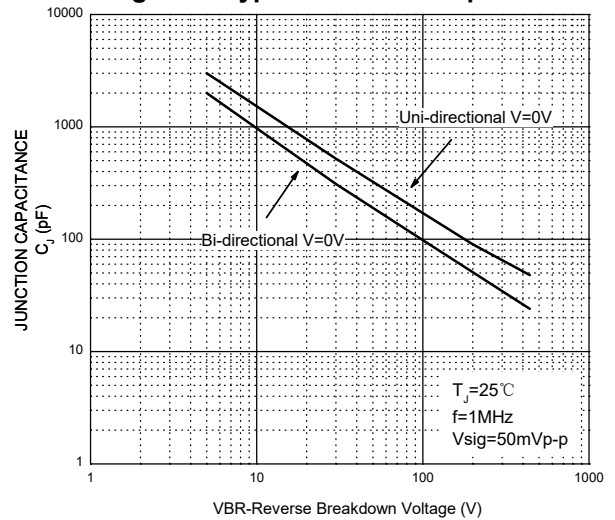

Figure 5. Steady State Power Dissipation Derating Curve

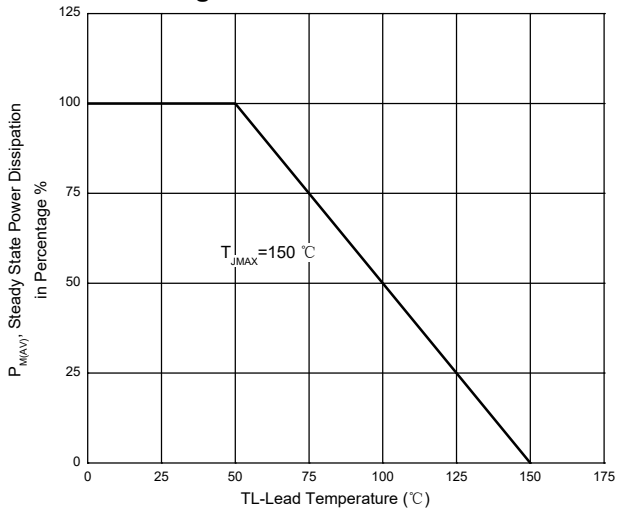
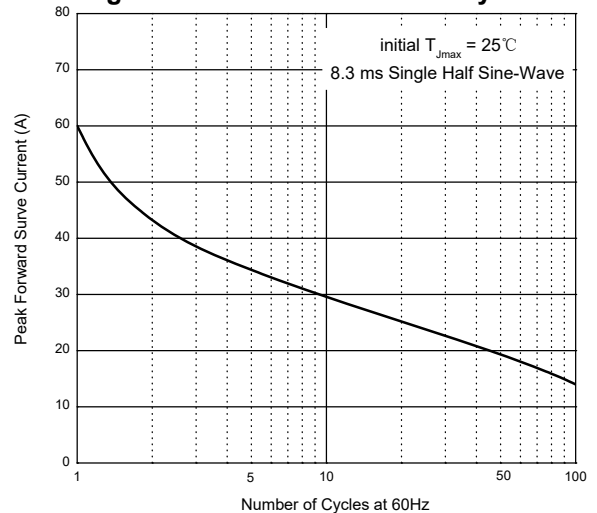
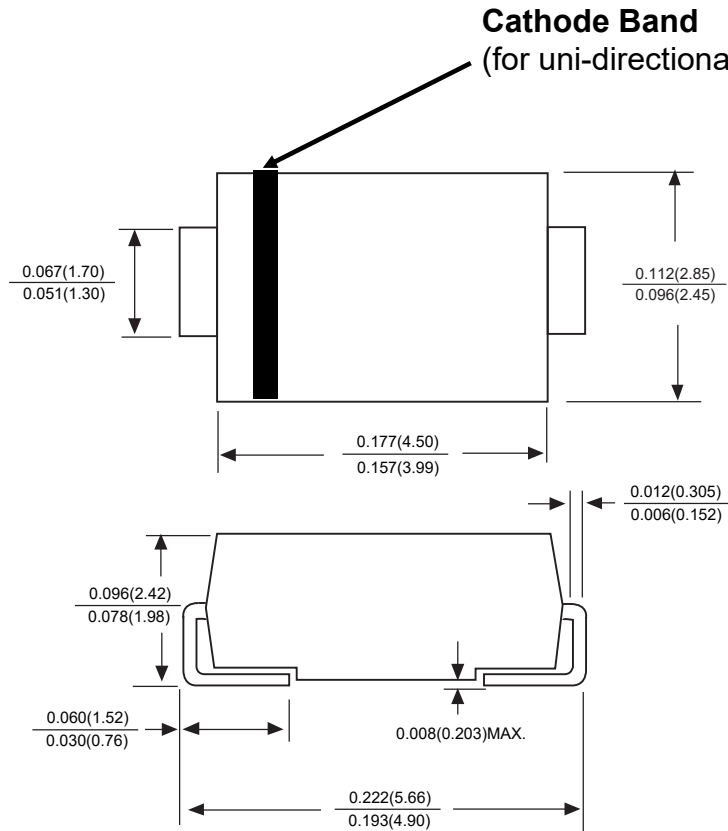

Figure 6. Maximum Non-Repetitive Forward Surge Current Uni-Directional Only



SMAG Package Outline Dimensions



Dimensions in inches and (millimeters)

SMAG Suggested Pad Layout

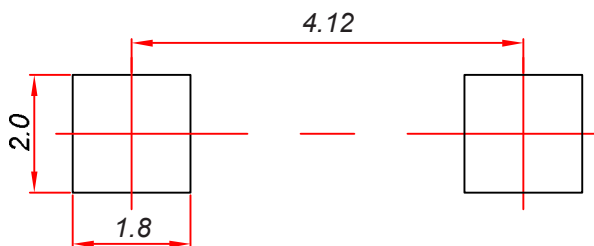

Note:

1. Controlling dimension: in millimeters.
2. General tolerance: ± 0.05 mm.
3. The pad layout is for reference purposes only.

NOTICE

JSCJ reserves the right to make modifications, enhancements, improvements, corrections or other changes without further notice to any product herein. JSCJ does not assume any liability arising out of the application or use of any product described herein.

Reel Taping Specifications For Surface Mount Devices- SMAG

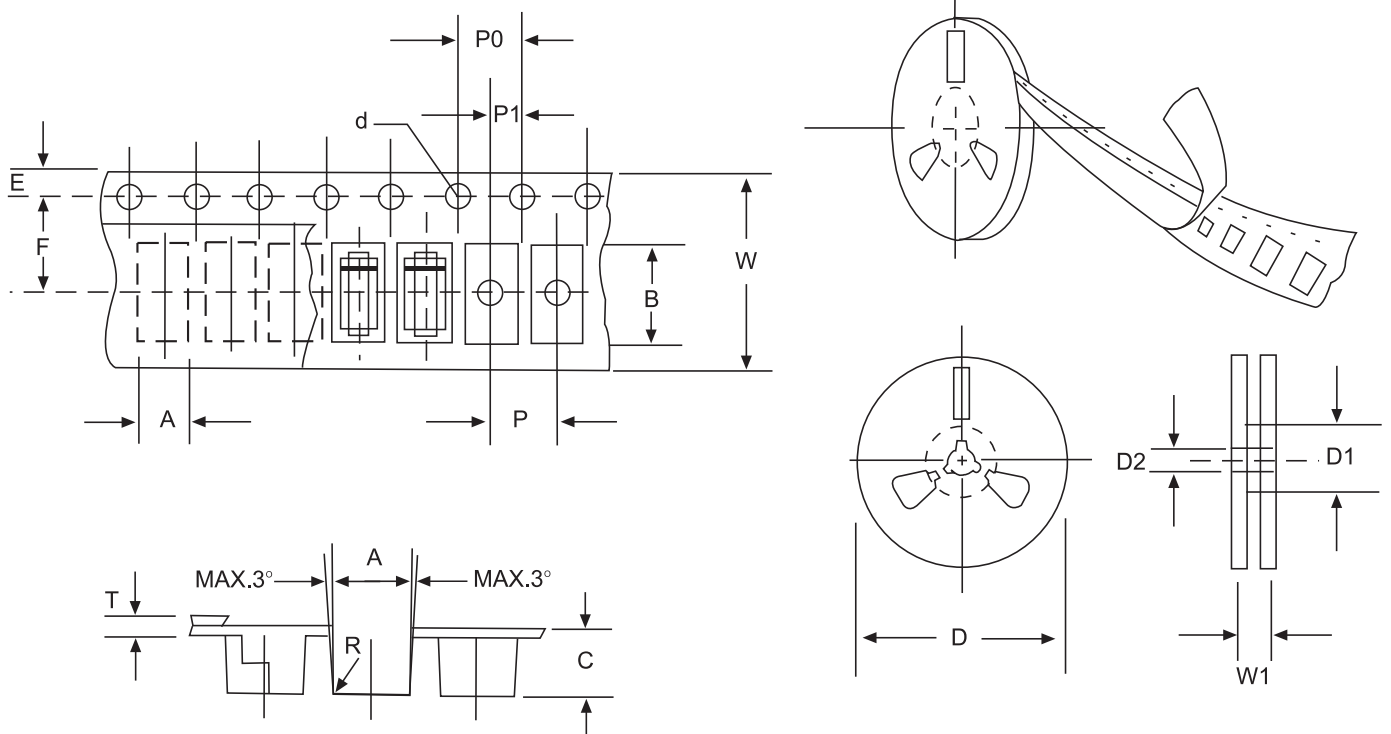

FIG: CONFIGURATION OF SURFACE MOUNTED DEVICES TAPING

ITEM	SYMBOL	SMAG mm (inch)
Carrier width	A	2.79±0.1 (0.110±0.004)
Carrier length	B	5.33±0.1 (0.210±0.004)
Carrier depth	C	2.36±0.1 (0.093±0.004)
Sprocket hole	d	1.55±0.05 (0.061±0.002)
Reel outside diameter	D	279±2.0 (11±0.079)
Reel inside diameter	D1	75±1.0 (2.95±0.039)
Feed hole position	D2	13±0.5 (0.512±0.020)
Strocket hole position	E	1.75±0.1 (0.069±0.004)
Punch hole position	F	5.5±0.05 (0.217±0.002)
Punch hole pitch	P	4.0±0.1 (0.157±0.004)
Strocket hole pitch	P0	4.0±0.1 (0.157±0.004)
Embossment center	P1	2.0±0.1 (0.079±0.004)
Total tape thickness	T	0.28±0.02 (0.011±0.0008)
Tape width	W	12.0±0.2 (0.472±0.008)
Reel width	W1	16.8±2.0 (0.661±0.069)

NOTE: Devices are packed in accordance with EIA standard RS-481-A and specification given above.